

Series 6100 Installation Guide for 3/16" Cable Invisiware® Receivers with Push-Lock™ Fittings

Materials/tools required _____

- * **Cable Gripping Pliers** — (50TCG1)
Used to grip the cable while tensioning the end fittings without damaging the cable.
[OPTION: Use a piece of rubber hose with vice grips around the cable to prevent scarring.]
- * **Cable Cutter 3/16"** — (82T13)
- * **3/16" Hex Allen Key**
- * **Drill**
- * **Drill Bits:**
 - **29/64"**
 - **7/32"** (If there are intermediate posts between the terminating end posts or where the length of the receiver or Push-Lock™ fitting you are using is less than the thickness of the end post)
 - **15/16"** (If you wish to counterbore the wood end post to recess the 11HW14 washer)



Drill posts _____

Terminating (end) post for Invisiware® receivers — Drill a 29/64" hole from the back side of the end posts where each cable will be installed. For a 1-1/2" or less square end post using a 1-1/2" long receiver, a 2" end post using a 2" long receiver, a 2-3/8" end post using a 2-3/8" long receiver, or a standard 4x4 using a 3-1/2" long receiver, drill the hole completely through the post. For posts thicker than the length of the receiver, drill a 7/32" pilot hole completely through the post, then drill a 29/64" hole only through the back surface of the end post (in the case of a wood post, to a depth a little greater than the length of the receiver) but not completely through the post.

Terminating (end) post for Push-Lock™ fittings — Drill a 29/64" hole from the back side of the end posts where each cable will be installed. For a 2" or less square end post, drill the hole completely through the post. For posts greater than 2" thick, drill a 7/32" pilot hole completely through the post, then drill a 29/64" hole only through the back surface of the end post (in the case of a wood post, to a depth a little greater than the length of the Push-Lock™ fitting) but not completely through the post.

Intermediate post or other element through which the cable will pass between the end posts — Drill 7/32" diameter holes lined up with the holes in the end post through which the cable will pass between end posts.

Install Invisiware® Receivers

1. Slide the washer (black plastic for metal posts, 11HW14 stainless steel for wood posts) over the body of the receiver, then feed the receiver through the hole in the back of the post.
2. By hand, screw the receiver body onto the swaged stud at least 6 full turns. Do not tension the cables at this point.

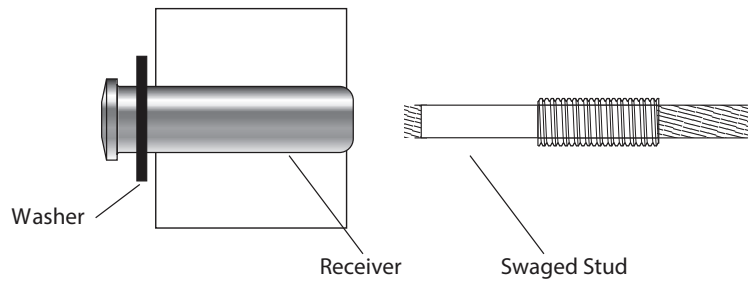

String the cable through the holes drilled in your intermediate posts (or other elements through which the cable passes between end posts) and through the end post where you will be installing the Push-Lock™ fitting.

See illustration below — Post A is the end post to which the receiver is attached; Post B is the end post to which the Push-Lock™ fitting is to be attached.

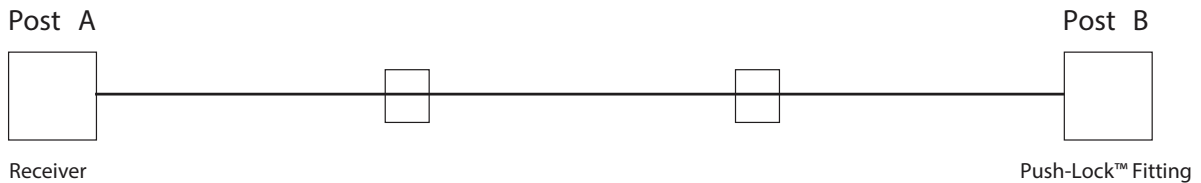

Install Push-Lock™ fittings

1. With the cable strung through the end post, cut the cable with a cable cutter (82T13), leaving enough cable extending out the back side of the post to be able to grasp the cable firmly with your hand (6" or more).
2. Slide the washer (black plastic for metal posts, 11HW14 stainless steel for wood posts) over the body of the Push-Lock™ fitting.

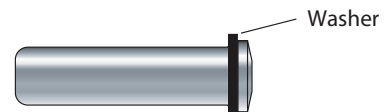
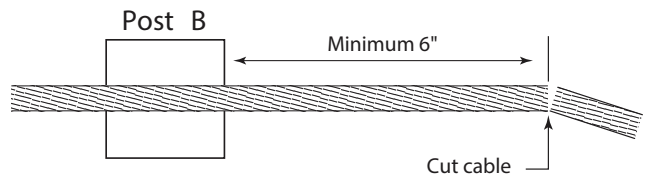

- Pull the cable tight and mark the cable at a point 'X' from the backside of the post.
Cut the cable at the mark, using a cable cutter (82T13).

PART. NO.	'L'	'X'
20FPL6	1.562"	0.375"
20FPL6-12	1.562"	0.375"
20FPL6-2	2.030"	0.875"
20FPL6-3	3.030"	1.875"

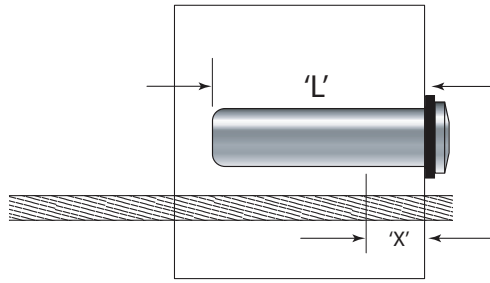

- Push the cable into the hole in the fitting as far as it will go (approximately 1-1/16"). Twist the cable in the right-hand direction (with the lay of the cable) as you push it into the fitting. You will feel it slide through the jaws inside the stud.

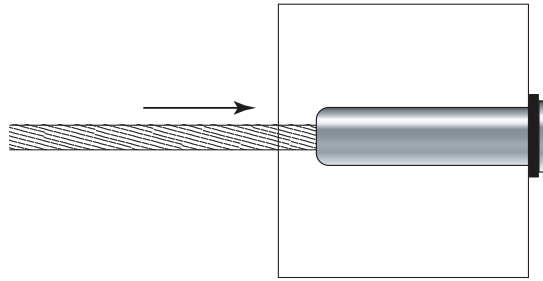

- Pull cable to set gripping action of the Push-Lock™ Fitting.

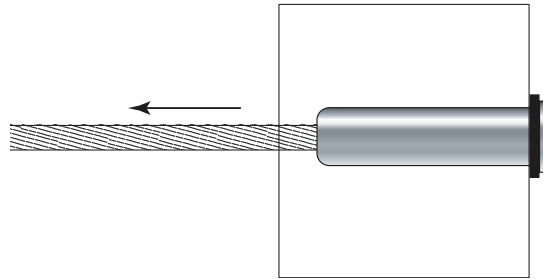

- Tension the cables.

After all the cables have been installed in both end posts, tension the cables with the receivers on the other end to approximately 150 lbs. per cable by holding the cable with cable gripping pliers (50TCG1) closely behind the stud. Turn the receiver clockwise with a 3/16" hex key as illustrated at right.
(See Page 4 for tensioning sequence)

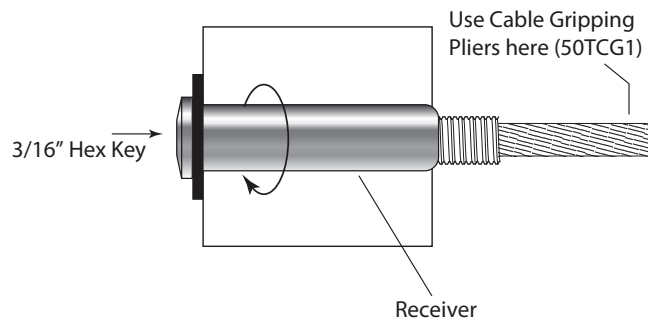

Tension in sequence,
beginning with the
outside cables and
moving from side to
side toward the center.

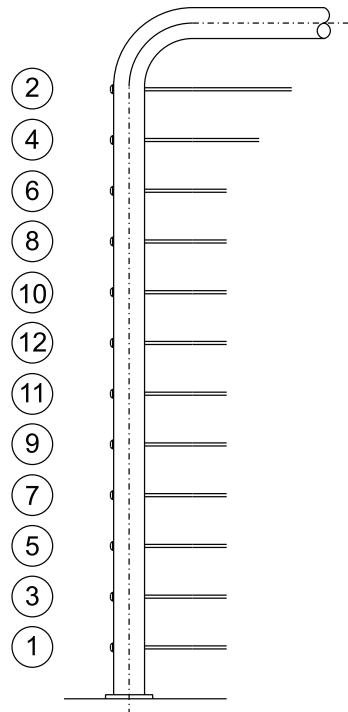

RECOMMENDED TENSIONING
SEQUENCE